

User's and Service Guide

Agilent Technologies 85031B 7 mm Calibration Kit



Agilent Part Number: 85031-90003

Printed in USA

Print Date: October 2010

Supersedes: August 2010

© Copyright 1989, 2001, 2002, 2008, 2010 Agilent Technologies, Inc. All rights reserved.

Documentation Warranty

THE MATERIAL CONTAINED IN THIS DOCUMENT IS PROVIDED "AS IS," AND IS SUBJECT TO BEING CHANGED, WITHOUT NOTICE, IN FUTURE EDITIONS. FURTHER, TO THE MAXIMUM EXTENT PERMITTED BY APPLICABLE LAW, AGILENT DISCLAIMS ALL WARRANTIES, EITHER EXPRESS OR IMPLIED WITH REGARD TO THIS MANUAL AND ANY INFORMATION CONTAINED HEREIN, INCLUDING BUT NOT LIMITED TO THE IMPLIED WARRANTIES OF MERCHANTABILITY AND FITNESS FOR A PARTICULAR PURPOSE. AGILENT SHALL NOT BE LIABLE FOR ERRORS OR FOR INCIDENTAL OR CONSEQUENTIAL DAMAGES IN CONNECTION WITH THE FURNISHING, USE, OR PERFORMANCE OF THIS DOCUMENT OR ANY INFORMATION CONTAINED HEREIN. SHOULD AGILENT AND THE USER HAVE A SEPARATE WRITTEN AGREEMENT WITH WARRANTY TERMS COVERING THE MATERIAL IN THIS DOCUMENT THAT CONFLICT WITH THESE TERMS, THE WARRANTY TERMS IN THE SEPARATE AGREEMENT WILL CONTROL.

DFARS/Restricted Rights Notice

If software is for use in the performance of a U.S. Government prime contract or subcontract, Software is delivered and licensed as "Commercial computer software" as defined in DFAR 252.227-7014 (June 1995), or as a "commercial item" as defined in FAR 2.101(a) or as "Restricted computer software" as defined in FAR 52.227-19 (June 1987) or any equivalent agency regulation or contract clause. Use, duplication or disclosure of Software is subject to Agilent Technologies' standard commercial license terms, and non-DOD Departments and Agencies of the U.S. Government will receive no greater than Restricted Rights as defined in FAR 52.227-19(c)(1-2) (June 1987). U.S. Government users will receive no greater than Limited Rights as defined in FAR 52.227-14 (June 1987) or DFAR 252.227-7015 (b)(2) (November 1995), as applicable in any technical data.

Assistance

Product maintenance agreements and other customer assistance agreements are available for Agilent products.

For any assistance, contact Agilent Technologies. Refer to "[Contacting Agilent](#)" on page 5-4

Printing Copies of Documentation from the Web

To print copies of documentation from the Web, download the PDF file from the Agilent web site:

- Go to www.agilent.com.
- Enter the document's part number (located on the title page) in the **Search** box.
- Click **Search**.
- Open the PDF and print the document.

Contents

1. General Information

Calibration Kit Overview	1-2
Kit Contents	1-2
Broadband Loads	1-2
Combination Open/Short	1-2
Calibration Definitions	1-2
Installation of the Calibration Definitions	1-3
Options	1-3
Equipment Required but Not Supplied	1-3
Incoming Inspection	1-3
Recording the Device Serial Numbers	1-4
Preventive Maintenance	1-4
When to Calibrate	1-5

2. Specifications

Environmental Requirements	2-2
Temperature—What to Watch Out For	2-2
Mechanical Characteristics	2-3
Pin Depth	2-3
Electrical Specifications	2-5
Certification	2-5

3. Use, Maintenance, and Care of the Devices

Electrostatic Discharge	3-2
Visual Inspection	3-3
Look for Obvious Defects and Damage First	3-3
What Causes Connector Wear?	3-3
Inspect the Mating Plane Surfaces	3-3
Cleaning Connectors	3-4
Gaging Connectors	3-6
Connector Gage Accuracy	3-6
When to Gage Connectors	3-6
Reading the Connector Gage	3-7
Gaging Procedure	3-8
Connections	3-11
How to Make a Connection	3-11
Preliminary Connection	3-11
Final Connection Using a Torque Wrench	3-11
How to Separate a Connection	3-13
Handling and Storage	3-13

4. Performance Verification

Introduction	4-2
How Agilent Verifies the Devices in Your Kit	4-2
Recertification	4-3
How Often to Recertify	4-3
Where to Send a Kit for Recertification	4-3

5. Troubleshooting	
Troubleshooting Process	5-2
Where to Look for More Information	5-3
Returning a Kit or Device to Agilent	5-3
Contacting Agilent.	5-4
6. Replaceable Parts	
Introduction	6-2
A. Standard Definitions	
Class Assignments and Standard Definitions Values are Available on the Web.	A-2

1 General Information

Calibration Kit Overview

The Agilent 85031B 7 mm calibration kit is used to calibrate Agilent network analyzers up to 6 GHz for measurements of components with 7 mm connectors.

Kit Contents

The 85031B calibration kit includes the following items:

- two 50 Ω broadband load terminations
- one combination open/short

Refer to [Figure 6-1](#) and [Table 6-1 on page 6-2](#) for a complete list of kit contents and their associated part numbers.

Broadband Loads

The broadband loads are metrology-grade terminations that have been optimized for performance up to 6 GHz. The rugged internal structure provides for highly repeatable connections. A distributed resistive element on sapphire provides excellent stability and return loss.

Combination Open/Short

The combination open/short is a precision standard device built from parts that are machined to the current state-of-the-art in precision machining.

This device is constructed so that the pin depth can be controlled very tightly, thereby minimizing phase errors. Refer to [“Pin Depth” on page 2-3](#) for additional information.

Calibration Definitions

The calibration kit must be selected and the calibration definitions for the devices in the kit installed in the network analyzer prior to performing a calibration. Refer to your network analyzer’s user’s documentation for instructions on selecting the calibration kit and performing a calibration.

The calibration definitions can be:

- already resident within the analyzer
- entered from the front panel

Class assignments and standard definitions may change as more accurate model and calibration methods are developed. You can download the most recent class assignments and standard definitions from Agilent’s Calibration Kit Definitions Web page at www.na.tm.agilent.com/pna/caldefs/stddefs.html.

Refer to your network analyzer user’s guide (8510 family) or online Help (PNA family) for instructions on selecting the calibration kit, installing (if necessary) the calibration definitions, and performing a calibration.

NOTE The 8510 network analyzer is no longer being sold or supported by Agilent. However, you can download the 8510 class assignments and standard definitions from Agilent's Calibration Kit Definitions Web page at www.na.tm.agilent.com/pna/caldefs/stddefs.html

Installation of the Calibration Definitions

The calibration definitions for the kit may be permanently installed in the internal memory or hard disk of the network analyzer.

If the calibration definitions for the kit are not permanently installed in the network analyzer, they must be manually entered. Refer to your network analyzer user's guide for instructions.

Options

The following options are available for the 85031B:

Option UK6

This option adds a certificate of calibration and the corresponding calibration data for the devices in the calibration kit.

Equipment Required but Not Supplied

Connector cleaning supplies and various electrostatic discharge (ESD) protection devices are not supplied with the calibration kit but are required to ensure successful operation of the kit. Refer to [Table 6-2 on page 6-3](#) for ordering information.

Incoming Inspection

Verify that the shipment is complete by referring to [Table 6-1 on page 6-2](#).

Check for damage. The foam-lined storage case provides protection during shipping. Verify that this case and its contents are not damaged.

If the case or any device appears damaged, or if the shipment is incomplete, contact Agilent Technologies. See "[Contacting Agilent](#)" on [page 5-4](#). Agilent will arrange for repair or replacement of incomplete or damaged shipments without waiting for a settlement from the transportation company.

When you send the kit or device to Agilent, include a service tag (found after the index of this manual) with the following information:

- your company name and address
- the name of a technical contact person within your company, and the person's complete phone number

- the model number and serial number of the kit
- the part number and serial number of the device
- the type of service required
- a *detailed* description of the problem

Recording the Device Serial Numbers

In addition to the kit serial number, the devices in the kit are individually serialized (serial numbers are labeled onto the body of each device). Record these serial numbers in [Table 1-1](#). Recording the serial numbers will prevent confusing the devices in the kit with similar devices from other kits.

The adapters included in the kit are for measurement convenience only and are not serialized.

Table 1-1 Serial Number Record for the 85031B

Device	Serial Number
Calibration kit	_____
Broadband load	_____
Broadband load	_____
Combination open/short	_____

Preventive Maintenance

The best techniques for maintaining the integrity of the devices in the kit include:

- routine visual inspection
- cleaning
- proper gaging
- proper connection techniques

All of these are described in [Chapter 3](#). Failure to detect and remove dirt or metallic particles on a mating plane surface can degrade repeatability and accuracy and can damage any connector mated to it. Improper connections, resulting from pin depth values being out of specification (see [Table 2-2 on page 2-3](#)), or from bad connection techniques, can also damage these devices.

When to Calibrate

A network analyzer calibration remains valid as long as the changes in the systematic error are insignificant. This means that changes to the uncorrected leakages (directivity and isolation), mismatches (source match and load match), and frequency response of the system are small (<10%) relative to accuracy specifications.

Change in the environment (especially temperature) between calibration and measurement is the major cause in calibration accuracy degradation. The major effect is a change in the physical length of external and internal cables. Other important causes are dirty and damaged test port connectors and calibration standards. If the connectors become dirty or damaged, measurement repeatability and accuracy is affected.

Fortunately, it is relatively easy to evaluate the general validity of the calibration. To test repeatability, remeasure one of the calibration standards. If you can not obtain repeatable measurements from your calibration standards, maintenance needs to be performed on the test port connectors, cables and calibration standards. Also, maintain at least one sample of the device under test or some known device as your reference device. A verification kit may be used for this purpose. After calibration, measure the reference device and note its responses. Periodically remeasure the device and note any changes in its corrected response which can be attributed to the test system. With experience you will be able to see changes in the reference responses that indicate a need to perform the measurement calibration again.

2 Specifications

Environmental Requirements

Table 2-1 Environmental Requirements

Parameter	Limits
Temperature	
Operating ^a	+15 °C to +35 °C
Storage	-40 °C to +75 °C
Error-corrected range ^b	± 1 °C of measurement calibration temperature
Relative humidity	Type tested, 0% to 95% at 40 °C, non-condensing

- a. The temperature range over which the calibration standards maintain conformance to their specifications.
- b. The allowable network analyzer ambient temperature drift during measurement calibration and during measurements when the network analyzer error correction is turned on. Also, the range over which the network analyzer maintains its specified performance while correction is turned on.

Temperature—What to Watch Out For

Changes in temperature can affect electrical characteristics. Therefore, the operating temperature is a critical factor in performance. During a measurement calibration, the temperature of the calibration devices must be stable and within the range shown in [Table 2-1](#).

IMPORTANT Avoid unnecessary handling of the devices during calibration because your fingers are a heat source.

Mechanical Characteristics

Mechanical characteristics such as center conductor protrusion and pin depth are *not* performance specifications. They are, however, important supplemental characteristics related to electrical performance. Agilent Technologies verifies the mechanical characteristics of the devices in the kit with special gaging processes and electrical testing. This ensures that the device connectors do not exhibit any center conductor protrusion or improper pin depth when the kit leaves the factory.

“Gaging Connectors” on page 3-6 explains how to use gages to determine if the kit devices have maintained their mechanical integrity. Refer to Table 2-2 for pin depth specifications.

Pin Depth

Pin depth is the distance the center conductor mating plane differs from being flush with the outer conductor mating plane. See Figure 2-1. on page 2-4. The pin depth of a connector can be in one of two states: either protruding or recessed.

Protrusion is the condition in which the center conductor extends beyond the outer conductor mating plane. This condition will indicate a positive value on the connector gage.

Recession is the condition in which the center conductor is set back from the outer conductor mating plane. This condition will indicate a negative value on the connector gage.

The pin depth value of each calibration device in the kit is not specified, but is an important mechanical parameter. The electrical performance of the device depends, to some extent, on its pin depth. The electrical specifications for each device in the kit take into account the effect of pin depth on the device’s performance. Table 2-2 lists the typical pin depths for the devices in the kit. If the pin depth of a device does not measure within the observed pin depth limits, it may be an indication that the device fails to meet electrical specifications. Refer to Figure 2-1. on page 2-4 for a visual representation of proper pin depth (slightly recessed).

Table 2-2 Pin Depth Limits

Device	Typical Pin Depth Inches Millimeters
Lowband load	-0.0002 to -0.0025 -0.0051 to -0.0635
Combination open/short	Open: 0 to -0.001 0 to -0.0254 Short: +0.0001 to -0.0001 +0.00254 to -0.00254

NOTE Center conductor recession with collet removed = 0.000 to 0.002 inches.

Figure 2-1. Connector Pin Depth

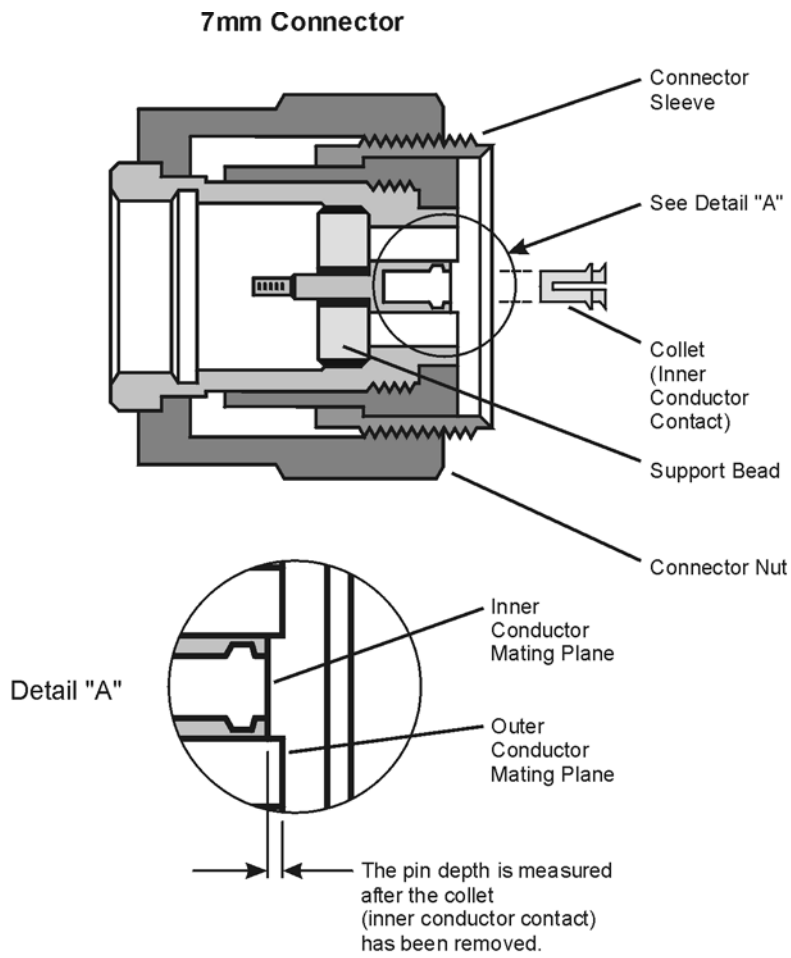

pi51b

Electrical Specifications

The electrical specifications in [Table 2-3](#) apply to the devices in your calibration kit when connected with an Agilent precision interface.

Table 2-3 Electrical Specifications for the 85031B 7 mm Devices

Device	Specification	Frequency (GHz)
Broadband loads	Return loss ≥ 52 dB	dc to ≤ 5
	Return loss ≥ 46 dB	> 5 to ≤ 6
	Return loss ≥ 26.4 dB (typical)	> 6 to ≤ 18

Certification

Agilent Technologies certifies that this product met its published specifications at the time of shipment from the factory. Agilent further certifies that its calibration measurements are traceable to the United States National Institute of Standards and Technology (NIST) to the extent allowed by the institute's calibration facility, and to the calibration facilities of other International Standards Organization members. See [“How Agilent Verifies the Devices in Your Kit”](#) on page 4-2 for more information.

3 Use, Maintenance, and Care of the Devices

Electrostatic Discharge

Protection against electrostatic discharge (ESD) is essential while connecting, inspecting, or cleaning connectors attached to a static-sensitive circuit (such as those found in test sets).

Static electricity can build up on your body and can easily damage sensitive internal circuit elements when discharged. Static discharges too small to be felt can cause permanent damage. Devices such as calibration components and devices under test (DUT), can also carry an electrostatic charge. To prevent damage to the test set, components and devices:

- *always* wear a grounded wrist strap having a 1 M Ω resistor in series with it when handling components and devices or when making connections to the test set.
- *always* use a grounded antistatic mat in front of your test equipment.
- *always* wear a heel strap when working in an area with a conductive floor. If you are uncertain about the conductivity of your floor, wear a heel strap.
- *Always* ground the center conductor of a test cable before making a connection to the analyzer test port or other static-sensitive device. This can be done as follows:
 1. Connect a short (from your calibration kit) to one end of the cable to short the center conductor to the outer conductor.
 2. While wearing a grounded wrist strap, grasp the outer shell of the cable connector.
 3. Connect the other end of the cable to the test port.
 4. Remove the short from the cable.

Figure 3-1 shows a typical ESD protection setup using a grounded mat and wrist strap. Refer to [Chapter 6, “Replaceable Parts,”](#) for information on ordering supplies for ESD protection.

Figure 3-1 ESD Protection Setup

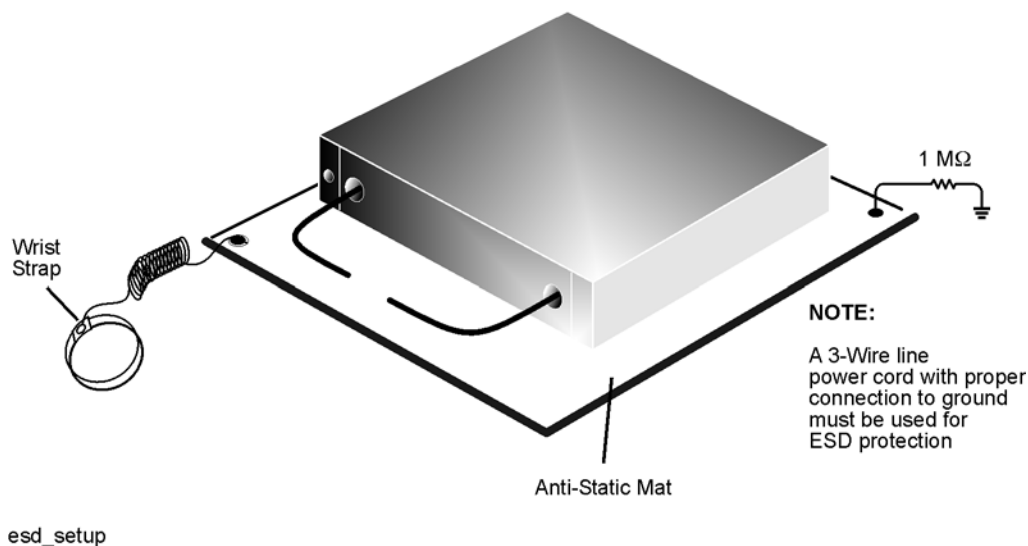

Visual Inspection

Visual inspection and, if necessary, cleaning should be done every time a connection is made. Metal particles from the connector threads may fall into the connector when it is disconnected. One connection made with a dirty or damaged connector can damage both connectors beyond repair.

Magnification is helpful when inspecting connectors, but it is not required and may actually be misleading. Defects and damage that cannot be seen without magnification generally have no effect on electrical or mechanical performance. Magnification is of great use in analyzing the nature and cause of damage and in cleaning connectors, but it is not required for inspection.

Look for Obvious Defects and Damage First

Examine the connectors first for obvious defects and damage: badly worn plating on the connector interface, deformed threads, or bent, broken, or misaligned center conductors. Connector nuts should move smoothly and be free of burrs, loose metal particles, and rough spots.

What Causes Connector Wear?

Connector wear is caused by connecting and disconnecting the devices. The more use a connector gets, the faster it wears and degrades. The wear is greatly accelerated when connectors are not kept clean, or are connected incorrectly.

Connector wear eventually degrades performance of the device. Calibration devices should have a long life if their use is on the order of a few times per week. Replace devices with worn connectors.

The test port connectors on the network analyzer test set may have many connections each day, and are therefore more subject to wear. It is recommended that an adapter be used as a test port saver to minimize the wear on the test set's test port connectors.

Inspect the Mating Plane Surfaces

Flat contact between the connectors at all points on their mating plane surfaces is required for a good connection. See [Figure 2-1. on page 2-4](#). Look especially for deep scratches or dents, and for dirt and metal particles on the connector mating plane surfaces. Also look for signs of damage due to excessive or uneven wear or misalignment.

Light burnishing of the mating plane surfaces is normal, and is evident as light scratches or shallow circular marks distributed more or less uniformly over the mating plane surface. Other small defects and cosmetic imperfections are also normal. None of these affect electrical or mechanical performance.

If a connector shows deep scratches or dents, particles clinging to the mating plane surfaces, or uneven wear, clean and inspect it again. Devices with damaged connectors should be discarded. Determine the cause of damage before connecting a new, undamaged connector in the same configuration.

Cleaning Connectors

Clean connectors are essential for ensuring the integrity of RF and microwave coaxial connections.

1. Use Compressed Air or Nitrogen

WARNING Always use protective eyewear when using compressed air or nitrogen.

Use compressed air (or nitrogen) to loosen particles on the connector mating plane surfaces. Clean air cannot damage a connector or leave particles or residues behind.

You can use any source of clean, dry, low-pressure compressed air or nitrogen that has an effective oil-vapor filter and liquid condensation trap placed just before the outlet hose.

Ground the hose nozzle to prevent electrostatic discharge, and set the air pressure to less than 414 kPa (60 psi) to control the velocity of the air stream. High-velocity streams of compressed air can cause electrostatic effects when directed into a connector. These electrostatic effects can damage the device. Refer to [“Electrostatic Discharge” on page 3-2](#) of this chapter for additional information.

2. Clean the Connector Threads

WARNING Keep isopropyl alcohol away from heat, sparks, and flame. Store in a tightly closed container. It is extremely flammable. In case of fire, use alcohol foam, dry chemical, or carbon dioxide; water may be ineffective.

Use isopropyl alcohol with adequate ventilation and avoid contact with eyes, skin, and clothing. It causes skin irritation, may cause eye damage, and is harmful if swallowed or inhaled. It may be harmful if absorbed through the skin. Wash thoroughly after handling.

In case of spill, soak up with sand or earth. Flush spill area with water.

Dispose of isopropyl alcohol in accordance with all applicable federal, state, and local environmental regulations.

Use a lint-free swab or cleaning cloth moistened with isopropyl alcohol to remove any dirt or stubborn contaminants on a connector that cannot be removed with compressed air or nitrogen. Refer to [Table 6-2 on page 6-3](#) for a part number for cleaning swabs.

- a. Apply a small amount of isopropyl alcohol to a lint-free cleaning swab.
- b. Clean the connector threads.
- c. Let the alcohol evaporate, then blow the threads dry with a gentle stream of clean, low-pressure compressed air or nitrogen. Always completely dry a connector before you reassemble or use it.

3. Clean the Mating Plane Surfaces

NOTE It is not necessary to remove the center conductor collet to clean a precision 7 mm connector.

- a. Place a lint-free cleaning cloth on a flat surface.
- b. Apply a small amount of isopropyl alcohol to a clean area of the cleaning cloth.
- c. Retract the connector sleeve threads to expose the connector interface.
- d. Gently press the contact end of the connector into the moistened cloth and rotate the connector. The cloth scrubs away dirt and contaminants on the connector interface without damaging it.
- e. Blow the connector dry with a gentle stream of clean, low-pressure compressed air or nitrogen. Always completely dry a connector before you reassemble or use it.

Store the cleaning cloth in a plastic bag or a box so that it does not collect dust or dirt.

4. Inspect

Inspect the connector to make sure that no particles or residue remain. Refer to [“Visual Inspection” on page 3-3](#).

Gaging Connectors

The gages available from Agilent Technologies are intended for preventive maintenance and troubleshooting purposes only. See [Table 6-2 on page 6-3](#) for part number information. They are effective in detecting excessive center conductor protrusion or recession, and conductor damage on DUTs, test accessories, and the calibration kit devices. Do not use the gages for precise pin depth measurements.

Connector Gage Accuracy

The connector gages are only capable of performing coarse measurements. They do not provide the degree of accuracy necessary to precisely measure the pin depth of the kit devices. This is partially due to the repeatability uncertainties that are associated with the measurement. Only the factory—through special gaging processes and electrical testing—can accurately verify the mechanical characteristics of the devices.

With proper technique, the gages are useful in detecting gross pin depth errors on device connectors. To achieve maximum accuracy, random errors must be reduced by taking the average of at least three measurements having different gage orientations on the connector. Even the resultant average can be in error by as much as ± 0.0001 inch due to systematic (biasing) errors usually resulting from worn gages and gage masters. As the gages undergo more use, the systematic errors can become more significant in the accuracy of the measurement.

When to Gage Connectors

Gage a connector at the following times:

- Prior to using a device for the first time: record the pin depth measurement so that it can be compared with future readings. It will serve as a good troubleshooting tool when you suspect damage may have occurred to the device.

NOTE When measuring pin depth, the measured value (resultant average of three or more measurements) contains measurement uncertainty and is not necessarily the true value. Always compare the measured value with the observed pin depth limits (which account for measurement uncertainties) in [Table 2-2 on page 2-3](#) to evaluate the condition of device connectors.

- If either visual inspection or electrical performance suggests that the connector interface may be out of typical range (due to wear or damage, for example).
- If a calibration device is used by someone else or on another system or piece of equipment.
- Initially after every 100 connections, and after that as often as experience indicates.

Reading the Connector Gage

The gage dial is divided into increments of 0.0001 inch and major divisions of 0.001 inch (see [Figure 3-2](#)). For each revolution of the large dial, the smaller dial indicates a change of 0.01 inch. Use the small dial as the indicator of multiples of 0.01 inch. In most connector measuring applications, this value will be zero.

When making a measurement, the gage dial indicator will travel in one of two directions. If the center conductor is recessed from the *zero* reference plane, the indicator will move counterclockwise to indicate the amount of **recession**, which is read as a negative value. If the center conductor protrudes, the indicator will move clockwise to indicate the amount of **protrusion**, which is read as a positive value. Refer to [“Pin Depth” on page 2-3](#) for definitions of protrusion and recession.

Figure 3-2 Reading the Connector Gage

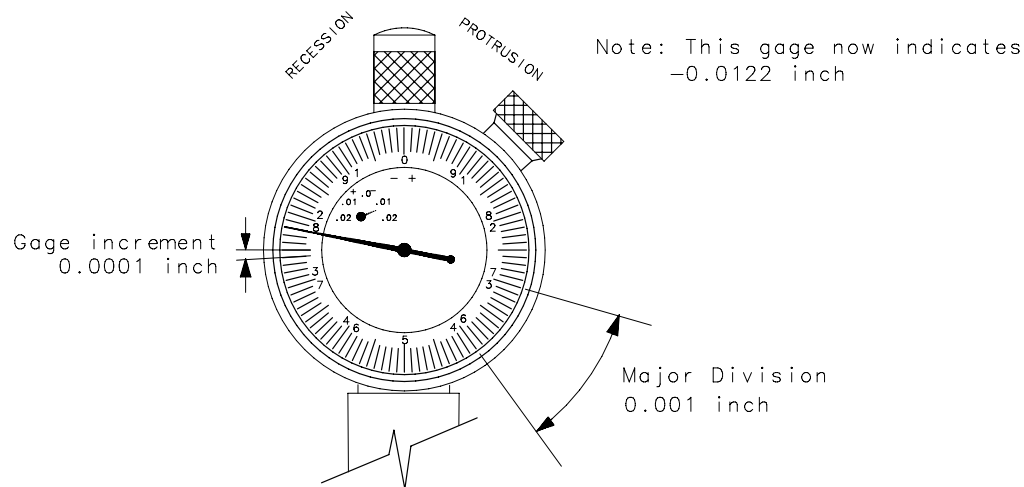

wj57f

Gaging Procedure

NOTE Always hold a connector gage by the gage barrel, below the dial indicator. This gives the best stability, and improves measurement accuracy.

1. Select the proper gage for your connector. Refer to [Table 6-2 on page 6-3](#) for gage part number.
2. Inspect and clean the gage, gage master, and device to be gaged. Refer to [“Visual Inspection” on page 3-3](#) and [“Cleaning Connectors” on page 3-4](#) of this chapter.
3. Zero the connector gage (refer to [Figure 3-3](#)):
 - a. While holding the gage by the barrel, and without turning the gage or the device, connect the gage master to the gage. Refer to [“Connections” on page 3-11](#) for more information. Connect the nut finger tight. Do not overtighten.
 - b. Using an open-end wrench to keep the gage from rotating, use the torque wrench recommended for use with the kit to tighten the gage master connector nut to the specified torque. Refer to [“Final Connection Using a Torque Wrench” on page 3-11](#) for more information.
 - c. The gage pointer should line up exactly with the zero mark on the gage. If not, loosen the dial lock screw on the gage and rotate the gage dial so that the pointer is aligned with the zero mark.
 - d. Tighten the dial lock screw and remove the gage master.
 - e. Attach and torque the gage master to the gage once again to verify that the setting is repeatable. Remove the gage master.
4. Gage the device connector (refer to [Figure 3-3](#)):
 - a. If gaging one of the 50Ω loads in the kit, use a collet extractor tool to remove the center conductor collet from the device connector to be gaged. Refer to [Table 6-2 on page 6-3](#) for the part number of this extractor tool. Refer to [Figure 2-1. on page 2-4](#) for an illustration of the 7 mm connector and the location of the center conductor collet.
 - b. While holding the gage by the barrel, and without turning the gage or the device, connect the gage master to the device. Refer to [“Connections” on page 3-11](#) for more information. Connect the nut finger-tight. Do not overtighten.
 - c. Using an open-end wrench to keep the gage from rotating, use the torque wrench recommended for use with the kit to tighten the device connector nut to the specified torque. Refer to [“Final Connection Using a Torque Wrench” on page 3-11](#) for more information.
 - d. Gently tap the barrel of the gage with your finger to settle the gage reading.
 - e. Read the gage indicator dial. If the needle has moved clockwise, the center conductor is *protruding* by an amount indicated by the *black* numbers. If the needle has moved counterclockwise, the center conductor is *recessed* by an amount indicated by the *red* numbers.

For maximum accuracy, measure the connector a minimum of three times and take an average of the readings. After each measurement, rotate the gage a quarter-turn to reduce measurement variations that result from the gage or the connector face not being exactly perpendicular to the center axis.

- f. Compare the average reading with the pin depth specifications listed in [Table 2-2 on page 2-3](#).
- g. Remove the device from the gage and replace the center conductor collet.

Figure 3-3 Gaging 7 mm Connectors

Zero the Connector Gage

- Connect the gage master to the gage.
- Torque the connecting nut.
- Loosen the dial lock screw.
- Rotate the gage dial so that the pointer is aligned with the zero mark.
- Tighten the dial lock screw.
- Remove the gage master.

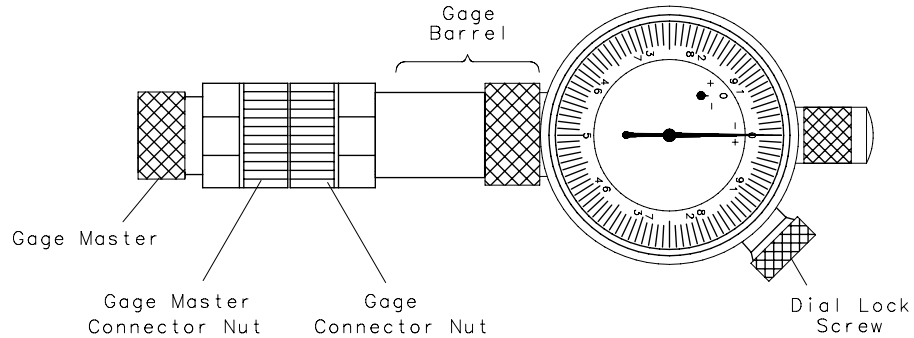

Gage the Device Connector

- Connect the device to the gage.
- Torque the connecting nut.
- Gently tap the gage barrel to settle the reading.
- Read recession or protrusion from the gage.
- Remove the device.
- Repeat two additional times and average the three readings.

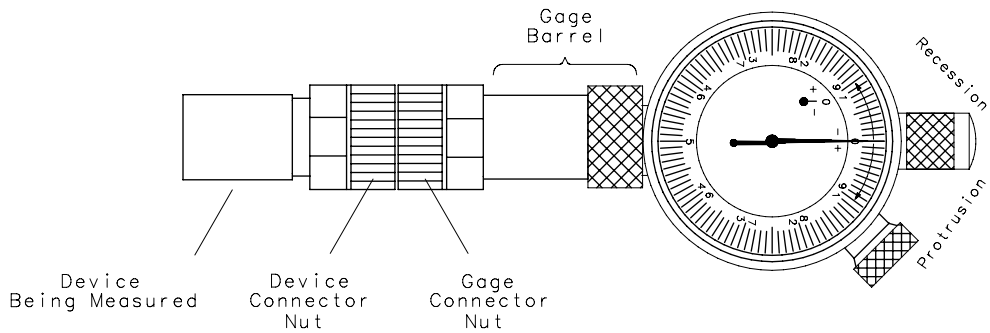

pi52b

Connections

Good connections require a skilled operator. *The most common cause of measurement error is bad connections.* The following procedures illustrate how to make good connections.

How to Make a Connection

Preliminary Connection

1. Ground yourself and all devices. Wear a grounded wrist strap and work on a grounded, conductive table mat. Refer to [“Electrostatic Discharge” on page 3-2](#) for ESD precautions.
2. Visually inspect the connectors. Refer to [“Visual Inspection” on page 3-3](#).
3. If necessary, clean the connectors. Refer to [“Cleaning Connectors” on page 3-4](#).
4. Use a connector gage to verify that all center conductors are within the pin depth specifications in [Table 2-2 on page 2-3](#). Refer to [“Gaging Connectors” on page 3-6](#).
5. Fully extend the connector sleeve on one of the connectors. Spin its knurled connector nut to make sure the threads are fully extended. Fully retract the sleeve on the other connector. The extended sleeve creates a cylinder into which the other connector fits.

If one of the connectors is fixed (such as on a test port), fully extend that connector sleeve and fully retract the sleeve on the moveable connector.
6. Carefully align the connectors. As you make the actual connection, be sure the connectors align perfectly.
7. Push the connectors straight together. Do *not* twist or screw the connectors together.
8. Engage the connector nut (of the connector with the retracted sleeve) over the threads of the other connector (the connector with the extended sleeve). Turn only the connector nut. Let the connector nut pull the two connectors straight together.
9. Do not overtighten this connection. A connection in which the outer conductors make gentle contact at all points on both mating surfaces is sufficient. Very light finger pressure is enough to accomplish this.
10. Make sure the connectors are properly supported. Relieve any side pressure on the connection from long or heavy devices or cables.

Final Connection Using a Torque Wrench

Use a torque wrench to make a final connection. [Table 3-1](#) provides information about the torque wrench recommended for use with the calibration kit. A torque wrench is not included in the calibration kit. Refer to [Table 6-2 on page 6-3](#) for part number and ordering information.

Table 3-1 Torque Wrench Information

Connector Type	Torque Setting	Torque Tolerance
7 mm	135 N-cm (12 in-lb)	±13.5 N-cm (±1.2 in-lb)

Using a torque wrench guarantees that the connection is not too tight, preventing possible connector damage. It also guarantees that all connections are equally tight each time.

Prevent the rotation of anything other than the connector nut that you are tightening. It may be possible to do this by hand if one of the connectors is fixed (as on a test port). However, it is recommended that you use an open-end wrench to keep the body of the device from turning.

1. Position both wrenches within 90 degrees of each other before applying force. See [Figure 3-4](#). Wrenches opposing each other (greater than 90 degrees apart) will cause a lifting action which can misalign and stress the connections of the devices involved. This is especially true when several devices are connected together.

Figure 3-4 Wrench Positions

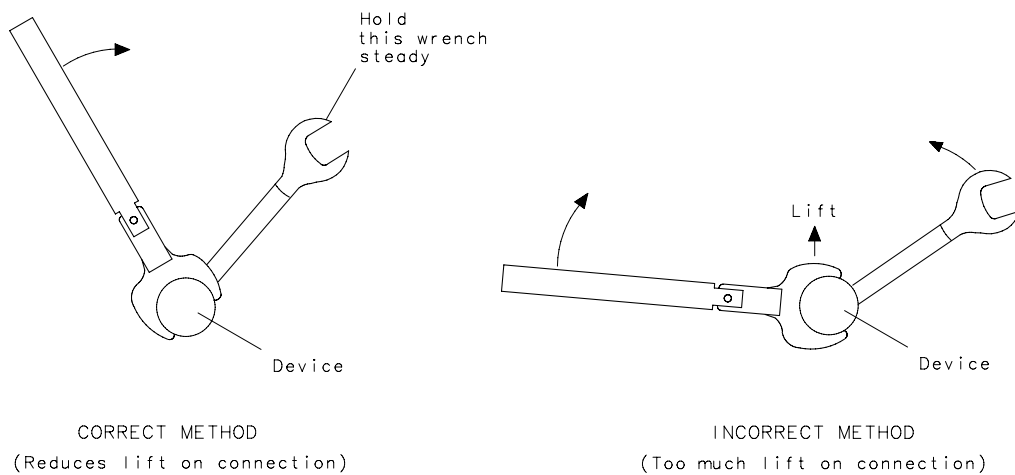

wj56f

2. Hold the torque wrench lightly, at the end of the handle only (beyond the groove). See [Figure 3-5](#).

Figure 3-5 Using the Torque Wrench

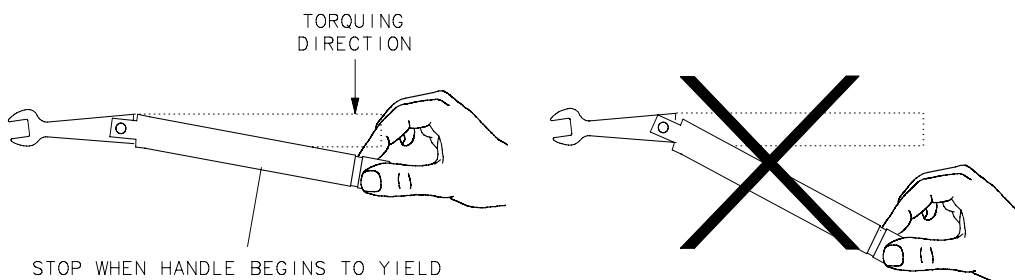

wj68d

3. Apply downward force perpendicular to the wrench handle. This applies torque to the connection through the wrench.

Do not hold the wrench so tightly that you push the handle straight down along its length rather than pivoting it, otherwise you apply an unknown amount of torque.

4. Tighten the connection just to the torque wrench break point. The wrench handle gives way at its internal pivot point. See [Figure 3-5 on page 3-12](#). Do not tighten the connection further.

CAUTION You don't have to fully break the handle of the torque wrench to reach the specified torque; doing so can cause the handle to kick back and loosen the connection. Any give at all in the handle is sufficient torque.

How to Separate a Connection

To avoid lateral (bending) force on the connector mating plane surfaces, always support the devices and connections.

CAUTION Do *not* turn the device body. Only turn the connector nut. Damage to the center conductor can occur if the device body is twisted.

1. Use an open-end wrench to prevent the device body from turning.
2. Use the torque wrench to loosen the connector nut.
3. Complete the separation by hand, turning only the connector nut.
4. Pull the connectors straight apart without twisting, rocking, or bending either of the connectors.

Handling and Storage

- Do install the protective end caps and store the calibration devices in the foam-lined storage case when not in use.
- Do keep connectors clean.
- Do *not* touch mating plane surfaces. Natural skin oils and microscopic particles of dirt are easily transferred to a connector interface and are very difficult to remove.
- Do *not* set connectors contact-end down on a hard surface. The plating and the mating plane surfaces can be damaged if the interface comes in contact with any hard surface.
- Do *not* store connectors loose in a box, or in a desk or bench drawer. This is the most common cause of connector damage during storage.

4 Performance Verification

Introduction

The performance of your calibration kit can only be verified by returning the kit to Agilent Technologies for recertification. The equipment required to verify the specifications of the devices in the kit has been specially manufactured and is not commercially available.

How Agilent Verifies the Devices in Your Kit

Agilent verifies the specifications of these devices as follows:

1. The residual microwave error terms of the test system are verified with precision airlines and shorts that are directly traced to the National Institute of Standards and Technology (NIST). The airline and short characteristics are developed from mechanical measurements. The mechanical measurements and material properties are carefully modeled to give very accurate electrical representation. The mechanical measurements are then traced to NIST through various plug and ring gages and other mechanical measurements.
2. Each calibration device is electrically tested on this system. For the initial (before sale) testing of the calibration devices, Agilent includes the test measurement uncertainty as a guardband to guarantee each device meets the published specification. For recertifications (after sale), no guardband is used and the measured data is compared directly with the specification to determine the pass or fail status. The measurement uncertainty for each device is, however, recorded in the calibration report that accompanies recertified kits.

These two steps establish a traceable link to NIST for Agilent to the extent allowed by the institute's calibration facility. The specifications data provided for the devices in the kit is traceable to NIST through Agilent Technologies.

Recertification

The following will be provided with a recertified kit:

- a new calibration sticker affixed to the case
- a certificate of calibration
- a calibration report for each device in the kit listing measured values, specifications, and uncertainties

NOTE A list of NIST traceable numbers may be purchased upon request to be included in the calibration report.

Agilent Technologies offers a *Standard* calibration for the recertification of the kit. For more information, contact Agilent Technologies. See [“Contacting Agilent” on page 5-4](#).

How Often to Recertify

The suggested initial interval for recertification is 12 months or sooner. The actual need for recertification depends on the use of the kit. After reviewing the results of the initial recertification, you may establish a different recertification interval that reflects the usage and wear of the kit.

NOTE The recertification interval should begin on the date the kit is *first used* after the recertification date.

Where to Send a Kit for Recertification

Contact Agilent for information on where to send your kit for recertification. For contact information, see [“Contacting Agilent” on page 5-4](#).

5 Troubleshooting

Troubleshooting Process

If you suspect a bad calibration, or if your network analyzer does not pass performance verification, follow the steps in [Figure 5-1](#).

Figure 5-1 Troubleshooting Flowchart

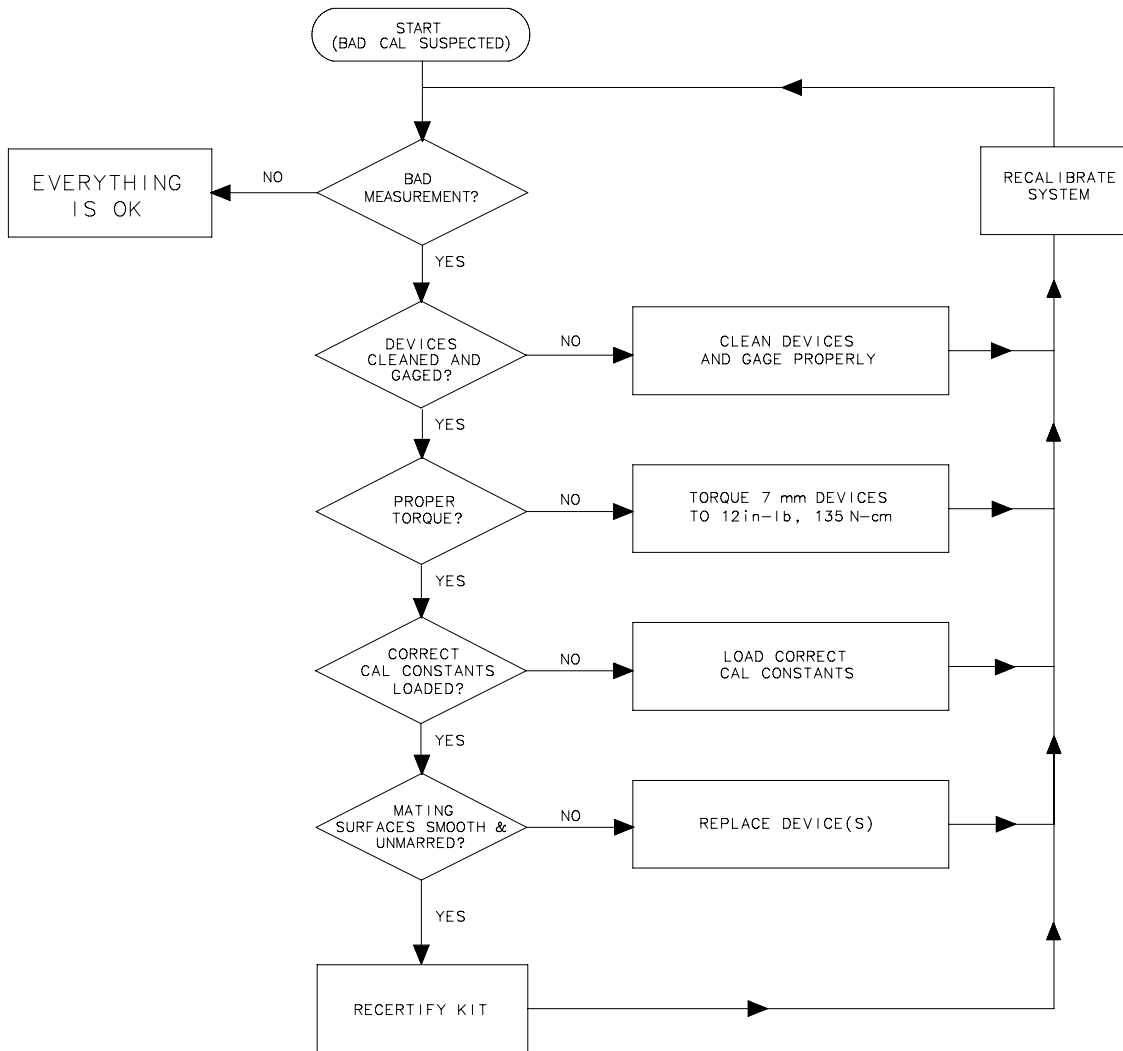

p153b

Where to Look for More Information

This manual contains limited information about network analyzer system operation. For detailed information on using a VNA, ENA or PNA series network analyzer, refer to the appropriate user guide or online Help.

- To view the ENA or PNA online Help, press the Help key on the front panel of the network analyzer.
- To view an online VNA user guide, use the following steps:
 1. Go to www.agilent.com.
 2. Enter your VNA model number (Ex: 8753ES) in the Search box and click **Search**.
 3. Under the heading **Manuals & Guides**, click on the title/hyperlink for the document PDF you want to view.

If you need additional information, see “[Contacting Agilent](#)” on page 5-4.

Returning a Kit or Device to Agilent

If your kit or device requires service, contact Agilent Technologies for information on where to send it. See “[Contacting Agilent](#)” on page 5-4 for contact information. Include a service tag (located near the end of this manual) on which you provide the following information:

- your company name and address
- a technical contact person within your company, and the person's complete telephone number
- the model number and serial number of the kit
- the part number and serial number of each device
- the type of service required
- a *detailed* description of the problem and how the device was being used when the problem occurred (such as calibration or measurement)

Contacting Agilent

Assistance with test and measurements needs and information on finding a local Agilent office are available on the Web at:

www.agilent.com/find/assist

If you do not have access to the Internet, please contact your Agilent field engineer.

NOTE In any correspondence or telephone conversation, refer to the Agilent product by its model number and full serial number. With this information, the Agilent representative can determine whether your product is still within its warranty period.

6 Replaceable Parts

Introduction

Table 6-1 lists the replacement part numbers for items included in the 85031B calibration kit and Figure 6-1 illustrates each of these items.

Table 6-2 lists the replacement part numbers for items not included in the calibration kit that are either required or recommended for successful operation of the kit.

To order a listed part, note the description, the part number, and the quantity desired. Telephone or send your order to Agilent Technologies. See “Contacting Agilent” on page 5-4.

Figure 6-1 Replaceable Parts for the 85031B Calibration Kit

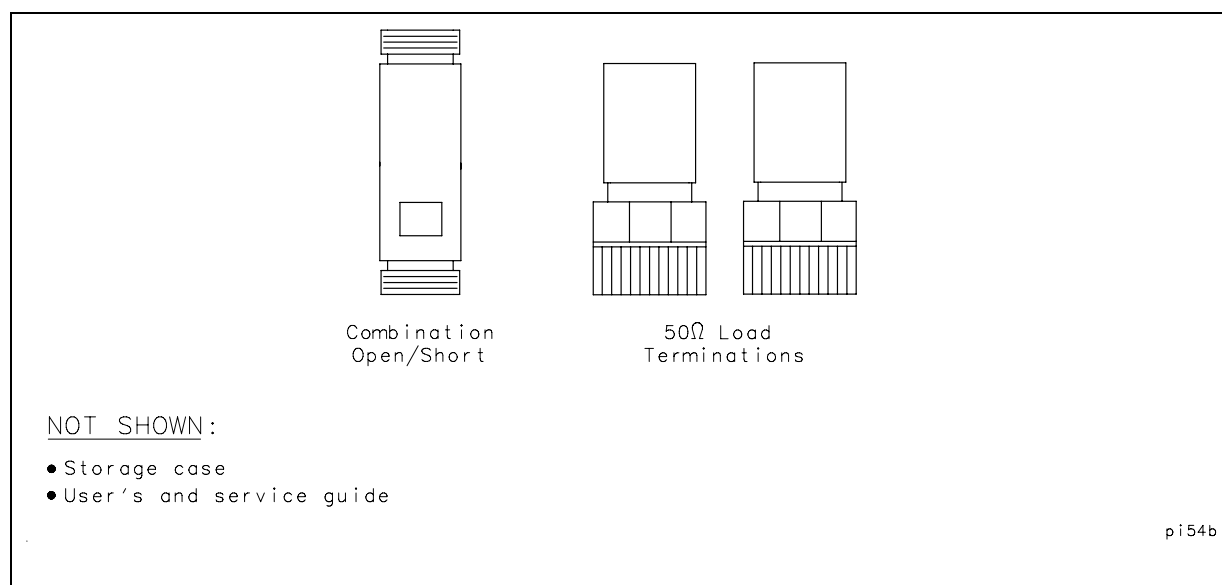

Table 6-1 Replaceable Parts for the 85031B Calibration Kit

Description	Qty per kit	Agilent Part Number
Calibration Devices (7 mm)		
Broadband load	2	00909-60008
Combination open/short	1	85031-60001
Calibration Kit Storage Case		
Box (without foam pad)	1	85031-80002
Box pad	1	85031-80003
User's and Service Guide		
User's and service guide ^a	1	85031-90003

a. See “Printing Copies of Documentation from the Web” on page -iii.

Table 6-2 Items Not Included in the Calibration Kit

Description	Qty	Agilent Part Number
Connector Gage (7 mm)		
Gage Set	1	85050-80012
Wrenches		
3/4 in, 135 N-cm (12 in-lb) torque wrench	1	8710-1766
1/2 in and 9/16 in open-end wrench	1	8710-1770
Collet and Collet Extractor Tool		
7 mm center conductor collet	1	85050-20001
7 mm connector collet extractor tool	1	5060-0370
ESD Protective Devices		
Grounding wrist strap	1	9300-1367
5 ft grounding cord for wrist strap	1	9300-0980
2 ft by 4 ft conductive table mat with 15 ft grounding wire	1	9300-0797
ESD heel strap	1	9300-1308
Connector Cleaning Supplies		
Anhydrous isopropyl alcohol (>92% pure) ^a	--	--
Foam-tipped cleaning swabs	100	9301-1243

a. Agilent can no longer safely ship isopropyl alcohol, so customers should purchase it locally.

A Standard Definitions

Class Assignments and Standard Definitions Values are Available on the Web

Class assignments and standard definitions may change as more accurate model and calibration methods are developed. You can download the most accurate class assignments and standard definitions from Agilent's Calibration Kit Definitions Web page at <http://na.tm.agilent.com/pna/caldefs/stddefs.html>.

For a detailed discussion of calibration kits, refer to the Agilent Application Note, "Specifying Calibration Standards and Kits for Agilent Vector Network Analyzers." This application note covers calibration standard definitions, calibration kit content and its structure requirements for Agilent vector network analyzers. It also provides some examples of how to set up a new calibration kit and how to modify an existing calibration kit definition file. To download a free copy, go to www.agilent.com and enter literature number 5989-4840EN in the Search window.

Numerics

8510 network analyzer, 1-3

A

Agilent Technologies
application note, A-2
contacting, 5-4

agreements

customer assistance, -ii
maintenance, -ii

alcohol

isopropyl
as cleaning solvent, 3-4
precautions for use of, 3-4

assistance

customer, -ii
who to contact, -ii

B

broadband loads, 1-2
part number, 6-2
specifications, 2-5

C

calibration

bad, 5-2
certificate of, 1-3, 4-3
constants, *See* calibration definitions
data, 1-3
definitions
permanently stored, 1-3
frequency, 1-5
report, 4-3
temperature, 2-2
when to perform, 1-5

calibration definitions, 1-2

entering, 1-2

calibration kit

Agilent Application Note, A-2
contents, 1-2, 6-2
drawing of, 6-2
modifying definition files, A-2
overview, 1-2
performance
how Agilent verifies, 4-2
verifying, 4-2

center conductor

protrusion, 3-7
recession, 3-7

certificate of calibration, 1-3, 4-3

certification

of device specifications, 2-5

characteristics

mechanical, 2-3

class assignments

downloading from Agilent Web
site, A-2

cleaning connectors, 3-4

cleaning supplies, 1-3
part number, 6-3

cleaning swabs, 3-4

part number, 6-3

compressed air

for cleaning, 3-4

connections, 3-2, 3-11

ESD protection, 3-11

final, 3-11

preliminary, 3-11

separating, 3-13

using torque wrench, 3-11

connector

cleaning, 3-4

damage, 3-3

defects, 3-3

gage

accuracy, 3-6

dial, 3-7

handling, 3-8

part number, 6-3

reading, 3-7

use of, 3-6

zeroing, 3-8

gaging, 3-6

when to do, 3-6

male, 3-8

mating plane surfaces, 3-5

cleaning, 3-5

threads

cleaning, 3-4

inspecting, 3-3

visual inspection, 3-3

wear, 3-3

affect on electrical

performance, 3-3

constants, calibration, *See*

calibration definitions

contacting Agilent Technologies,
5-4

contents

calibration kit, 6-2

drawing of, 6-2

incomplete

what to do, 1-3

D

damage

caused by electrostatic
discharge, 3-2

device, 3-3

inspecting for, 3-3

to connectors, 3-3

what to do, 1-3

damaged connectors, 3-3

data

calibration, 1-3

recertification, 4-3

defective connectors, 3-3

definitions

calibration, 1-2

entering, 1-2

permanently stored, 1-2

deviation from nominal phase, 2-5

device

connecting, 3-11

damage, 3-3

disconnecting, 3-13

handling, 3-13

maintenance, 1-4

performance

verifying, 4-2

specifications, 2-5

certification of, 2-5

traceability, 4-2, 4-3

storage, 3-13

temperature, 2-2

visual inspection, 3-3

dial

connector gage, 3-7

disconnections, 3-13

documentation warranty, -ii

downloading class assignments &
std definitions from the Web,
A-2

E

electrical specifications, 2-5

electrostatic discharge, *See* ESD

environmental

regulations, 3-4

requirements, 2-2

specifications, 2-2

equipment required, 1-3

ESD, 3-2

precautions, 3-4

protection, 3-2

supplies, 3-2

part numbers, 6-3

F

frequency

specifications, 2-5

frequency of calibration, 1-5

G

gage

connector

dial, 3-7

handling, 3-8

- reading, 3-7
- part number, 6-3
- zeroing, 3-8
- gaging
 - connectors, 3-6
 - when to do, 3-6
 - male connectors, 3-8
 - to determine pin depth, 3-6

H

- handling, 3-13
- how often to calibrate, 1-5
- humidity
 - specifications, 2-2

I

- incoming inspection, 1-3
- inspection
 - damage, 3-3
 - defects, 3-3
 - incoming, 1-3
 - mating plane surfaces, 3-3
 - visual, 3-3
- isopropyl alcohol
 - as cleaning solvent, 3-4
 - precautions for use of, 3-4

K

- kit
 - contents, 1-2, 6-2
 - drawing of, 6-2
 - overview, 1-2

L

- limits
 - pin depth, 2-3
- loads
 - broadband, 1-2

M

- maintenance, 3-2
 - agreements, -ii
 - of devices, 1-4
 - preventive, 1-4
- making connections, 3-11
 - ESD protection, 3-11
 - precautions, 3-11
- manual
 - printing copies, -iii
- mating plane surfaces
 - cleaning, 3-5
 - connector, 3-5
 - inspection of, 3-3
- mechanical characteristics, 2-3

- affect on electrical performance, 2-3
- verifying, 3-6
- modifying calibration kit
 - definition files, A-2

N

- National Institute of Standards and Technology (NIST), 2-5
- network analyzer, 8510, 1-3
- NIST, 4-2
- nitrogen
 - for cleaning, 3-4
- numbers
 - serial, 1-4
 - recording, 1-4

O

- observed limits
 - pin depth, 2-3
- offsets, 1-2
- open/short
 - part numbers, 6-2
- open-end wrench, 3-13
- opens, 1-2
 - specifications, 2-5
- options, 1-3
- ordering
 - parts, 6-2

P

- part numbers, 6-2
 - of items in kit, 6-2
 - of items not in kit, 6-3
- parts
 - included in kit, 6-2
 - not included in kit, 6-2
 - ordering, 6-2
 - replaceable, 6-2
- performance verification
 - fail, 5-2
- permanently stored calibration
 - definitions, 1-3
- pin depth, 2-3
 - affect on electrical performance, 2-3
 - gaging to determine, 3-6
 - observed limits, 2-3, 3-6
 - protrusion, 2-3
 - recession, 2-3
 - typical values, 2-3
- preventive maintenance, 1-4
- protrusion
 - center conductor, 3-7
 - pin depth, 2-3

R

- reading connector gage, 3-7
- recertification
 - how to order, 4-3
 - interval, 4-3
 - what's included, 4-3
 - where it's done, 4-3
- recession
 - center conductor, 3-7
 - pin depth, 2-3
- regulations
 - environmental, 3-4
- replaceable parts, 6-2
 - drawing of, 6-2
- report
 - calibration, 4-3
- requirements
 - environmental, 2-2
- return kit or device to Agilent, 5-3
- return loss
 - specifications, 2-5

S

- separating connections, 3-13
- serial numbers, 1-4
 - devices, 1-4
 - recording, 1-4
- service, 5-3
- service tag, 1-3, 4-3, 5-3
- shorts, 1-2
 - specifications, 2-5
- specifications, 2-2
 - certification of, 2-5
 - deviation from nominal phase, 2-5
 - device, 2-5
 - electrical, 2-5
 - environmental, 2-2
 - frequency, 2-5
 - humidity, 2-2
 - return loss, 2-5
 - temperature, 2-2
 - torque wrench, 3-11
 - traceability, 4-2, 4-3
- standard definitions
 - downloading from Agilent Web site, A-2
- standards
 - international, 2-5
 - national institute of, 2-5, 4-2
- static
 - discharge, 3-2
 - electricity, 3-2
- storage, 3-13
- supplies
 - cleaning, 1-3
 - part number, 6-3

Index

swabs
 cleaning, 3-4

T

tag
 service, 1-3, 4-3, 5-3

temperature
 affect on electrical performance,
 2-2
 calibration, 2-2
 cautions about, 2-2
 changes in, 2-2
 device, 2-2
 error-corrected, 2-2
 measurement, 2-2
 specifications, 2-2
 operating, 2-2
 storage, 2-2
 verification and measurement,
 2-2

test data, 4-3

threads
 connector
 cleaning, 3-4
 inspecting, 3-4

torque wrench
 part number, 6-3
 specifications, 3-11

traceability
 of device specifications, 4-2, 4-3

troubleshooting, 5-2

V

verification
 temperature, 2-2

visual inspection, 3-3

W

warranty, documentation, -ii

wear
 connector, 3-3
 affect on electrical
 performance, 3-3

when to calibrate, 1-5

wrench
 open-end, 3-12, 3-13
 proper positioning of, 3-12
 torque, 3-11, 3-12
 part number, 6-3
 proper use of, 3-12

Z

zeroing
 connector gage, 3-8